

HD 6/11-4M ST

A stand-alone pump unit for simple stationary and space-saving wall-mounted operation. A 3-point support on the back enables vertical or horizontal mounting.



Made in Germany



2-3 h



1 x 360°

EASY!Lock

Order no.

1.524-939.0

- Robust 4-pole low-speed AC motor
- Save time and energy: EASY!Force high-pressure gun and EASY!Lock quick-release fasteners
- Automatic pressure relief and up to 20 percent higher energy efficiency

Technical data

EAN code		4054278504940
Current type	Ph / V / Hz	1 / 100 / 50
Flow Rate	l/h	600
Water feed temperature	°C	60
Operating pressure	/ MPa	110 / 11
Max. Pressure	bar / MPa	165 / 16.5
Power rating	kW	2.9
Power cable	m	5
Water feed		3/4"
Colour		anthracite
Weight (with accessories)	kg	25
Weight incl. packaging	kg	27.5
Dimensions (L × W × H)	mm	290 × 300 × 565

Equipment

Pressure switch control

- included in delivery.

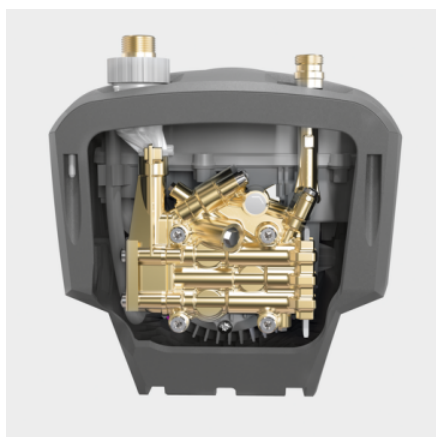

High-quality equipment

- Automatic pressure relief for protecting the components extends their service life.
- Powerful, 2-pole, air-cooled electric motor.
- High-quality brass cylinder head.



Flexible operation

- Designed for upright and horizontal operation.



Prepared for stationary operation

- Simple and robust 3-point attachment for wall mounting on the rear of unit.
- Space-saving, compact design.
- Integrated storage options reduce the set-up times.

EQUIPMENT FOR HD 6/11-4M ST 1.524-939.0

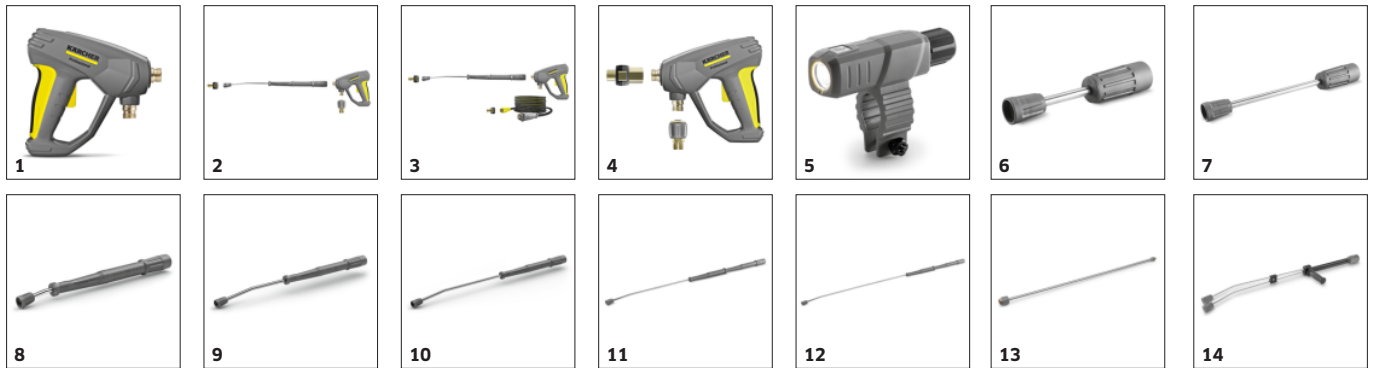

		Order no.	Description	
TRIGGER GUNS				
EASY!Force Advanced	1	4.118-005.0	Effortless, not energy-sapping: the EASY!Force high-pressure gun uses the recoil force of the high-pressure jet to reduce the holding force for the operator to zero.	<input type="checkbox"/>
EASY!Force conversion kit 1 - from high-pressure hose	2	4.111-050.0	For retrofitting Kärcher high-pressure cleaners with existing high-pressure hose: EASY!Force conversion kit 1 with EASY!Force high-pressure gun, spray lance and all adapters through to the nozzle.	<input type="checkbox"/>
EASY!Force conversion kit 2 - from machine	3	4.111-051.0	Developed for retrofitting existing high-pressure cleaners from Kärcher: EASY!Force conversion kit 2 with EASY!Force high-pressure gun, spray lance, high-pressure hose and necessary adapters.	<input type="checkbox"/>
EASY!Force conversion kit 3 - high-pressure gun	4	4.111-052.0	Compatible with existing high-pressure hose and spray lance: EASY!Force conversion kit 3, incl. EASY!Force trigger gun and all necessary adapters for upgrading your high-pressure cleaner.	<input type="checkbox"/>
SPRAY LANCES				
Rotating spray lances				
LED nozzle light	5	2.680-002.0	Bright, lightweight LED work light for direct mounting on spray lance of EASY!Force high-pressure gun. Better view in unfavourable lighting conditions for up to 5 working hours.	<input type="checkbox"/>
Spray lance, 250 mm, rotatable	6	4.112-027.0	Spray lance, 250 mm, rotatable, ergonomic	<input type="checkbox"/>
Spray lance, 400 mm, rotatable	7	4.112-024.0	Spray lance, 400 mm, rotatable, ergonomic	<input type="checkbox"/>
Spray lance, 600 mm, rotatable	8	4.112-007.0	600 mm stainless steel lance (manual coupling) with ergonomic handle for ease of use and protection. Rotatable 360° under pressure.	<input type="checkbox"/>
Spray lance, 840 mm, rotatable	9	4.112-006.0	850 mm stainless steel lance (manual coupling) with ergonomic handle for ease of use and protection. Rotatable 360° under pressure.	<input type="checkbox"/>
Spray lance, 1050 mm, rotatable	10	4.112-000.0	1050 mm stainless steel lance (manual coupling) with ergonomic handle for ease of use and protection. Rotatable 360° under pressure.	<input type="checkbox"/>
Spray lance, 1550 mm, rotatable	11	4.112-018.0	1550 mm stainless steel lance (manual coupling) with ergonomic handle for ease of use and protection. Rotatable 360° under pressure.	<input type="checkbox"/>
Spray lance, 2050 mm, rotatable	12	4.112-021.0	2050 mm stainless steel lance (manual coupling) with ergonomic handle for ease of use and protection. Rotatable 360° under pressure.	<input type="checkbox"/>
Spray lance extender, 1000 mm	13	4.112-048.0	Spray lance extension with EASY!Lock connection. Length 1000 mm.	<input type="checkbox"/>
Double lance				
Double lance, 960 mm	14	2.112-016.0	960 mm double lance for variable pressure adjustment on handle at full water flow rate. Suitable for agricultural use (e.g. stable cleaning).	<input type="checkbox"/>

■ Included in delivery. □ Available accessories.

EQUIPMENT FOR HD 6/11-4M ST 1.524-939.0



		Order no.	Description	
SPRAY LANCES				
Angular spray lance				
WC and gutter lance	15	4.112-029.0	Stainless steel lance WC and gutter with nozzle insert. Specially shaped for effective and hygienic cleaning of gutters and toilets.	<input type="checkbox"/>
Flexible spray lance				
Flexible lance, 1050 mm	16	4.112-035.0	1050 mm flexible lance with variable bend from 20° to 140°, ideal for cleaning difficult to reach areas, e.g. gutters.	<input type="checkbox"/>
High pressure articulated joint	17	4.112-057.0	For hard-to-reach areas: High-pressure articulated joint with infinite angle adjustment up to 120°. Simply attach directly to the spray lance of the pressure washer.	<input type="checkbox"/>
Gutter cleaner				
Gutter cleaning lance	18	2.112-015.0	The lance is suited for cleaning of gutter systems. Because of the shape of the lance and the special nozzle the gutter can be cleaned without removing the cover plates.	<input type="checkbox"/>
Undercarriage spray lance				
Underbody lance	19	4.112-032.0	Stainless steel lance for effective and easy underbody and wheel arch cleaning. Without high-pressure nozzle.	<input type="checkbox"/>
Additional handle				
Additional handle for EASY!Lock spray lances	20	4.321-380.0	Comfortable in every situation - the additional handle is easy to attach to the spray lance of our new EASY!Lock generation and makes work easier by allowing you to adjust your posture to suit the particular task.	<input type="checkbox"/>
ROTARY NOZZLES (DIRT BLASTERS)				
Dirt Blaster, small				
Dirt blaster, small, 045	21	4.114-021.0	Up to 50% higher cleaning and area performance than its predecessor: with the new performance dirt blaster (nozzle size 045), power losses have been minimised and the spray quality maximised.	<input type="checkbox"/>
Dirt blaster, large				
Dirt blaster, large, 045	22	4.114-042.0	The dirt blaster with rotating pencil jet offers 10 times better cleaning performance. Ceramic nozzle and bearing ring for a long service life. Further data: Max. 300 bar, 30 MPa, 85°C.	<input type="checkbox"/>
MULTIPLE-JET NOZZLES				
Triple nozzles				
Triple nozzle, 033	23	4.117-028.0	Triple nozzle with manual nozzle changeover. Convenient spray adjustment. For machines with an injector, the low-pressure flat stream is useful for cleaning agent suction and application.	<input type="checkbox"/>
Triple nozzle, 045	24	4.117-036.0		<input type="checkbox"/>
Angle vario nozzle 0°-90°				
Angled Vario nozzle, 050	25	4.113-007.0	Variable angle nozzle for spray angle adjustment from 0° to 90°. For easy adjustment to all kinds of soiling and surfaces.	<input type="checkbox"/>
KÄRCHER POWER NOZZLE				
HP nozzle spray angle 0°				
Power nozzle 0°, 045	26	2.113-033.0	High-pressure nozzle with powerful jet for extremely stubborn dirt.	<input type="checkbox"/>
Power nozzle spray angle 15°				
Power nozzle 15°, 045	27	2.113-046.0	Fan jet nozzle with 15° spray angle suitable for stubborn dirt.	<input type="checkbox"/>
Power nozzle spray angle 25°				
Power nozzle 25°, 045	28	2.113-022.0	Fan jet nozzle with 25° spray angle, suitable for large areas and removing stubborn dirt and stains.	<input type="checkbox"/>

■ Included in delivery. □ Available accessories.

EQUIPMENT FOR HD 6/11-4M ST 1.524-939.0

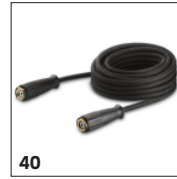
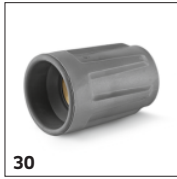

	Order no.	Description	
KÄRCHER POWER NOZZLE			
Power nozzle spray angle 40°			
Power Nozzle 40°, 045	29	2.113-053.0 Power nozzle with a 40° spray angle and fan jet, suitable for large areas and sensitive surfaces.	<input type="checkbox"/>
NOZZLE UNION / SPACER			
Nozzle union			
Nozzle screws	30	4.112-011.0 Nozzle screws with protectors for high-pressure and power nozzles	<input type="checkbox"/>
HIGH-PRESSURE HOSES			
Standard with unions on both sides			
High-pressure hose, 10 m, ID 10, 220 bar, 2 x EASY!Lock	31	6.110-041.0	<input type="checkbox"/>
High-pressure hose, 10 m, ID 6, 250 bar, 2 x EASY!Lock	32	6.110-034.0 10 m high-pressure hose (M 22 x 1.5) with kink protection. With patented rotating AVS trigger gun connector and manual coupling. Further data: DN 6/155°C/250 bar.	<input type="checkbox"/>
	33	6.110-035.0	<input type="checkbox"/>
High-pressure hose, 10 m, ID 6, 300 bar, 2 x EASY!Lock	34	6.110-056.0 With patented AVS connection in the trigger gun (pivot-mounted) and hand screw union. M 22 x 1.5 with anti-kink protection. NW 6/155°C/300 bar	<input type="checkbox"/>
High-pressure hose, 10 m, ID 8, 315 bar, 2 x EASY!Lock	35	6.110-031.0 10 m high-pressure hose (M 22 x 1.5) with kink protection. With patented rotating TR22 trigger gun connector and manual coupling. Further data: DN 8/155°C/315 bar.	<input type="checkbox"/>
High-pressure hose, 15 m, ID 8, 315 bar, 2 x EASY!Lock	36	6.110-030.0 15 m high-pressure hose (M 22 x 1.5) with kink protection. With patented rotating AVS trigger gun connector and manual coupling. Further data: DN 8/155°C/315 bar.	<input type="checkbox"/>
High-pressure hose, 20 m, ID 8, 315 bar, 2 x EASY!Lock	37	6.110-032.0 20 m high-pressure hose (M 22 x 1.5) with kink protection. With patented rotating AVS trigger gun connector and manual coupling. Further data: DN 8/155°C/315 bar.	<input type="checkbox"/>
High-pressure hose, 30 m, ID 8, 315 bar, 2 x EASY!Lock	38	6.110-014.0 With rotary coupling, 2 x M 22 x 1.5	<input type="checkbox"/>
High-pressure hose, 15 m, ID 10, 220 bar, 2 x EASY!Lock	39	6.110-042.0 15 m high-pressure hose M 22 x 1.5) with kink protection and threaded couplings at both ends. Further data: DN 10/155°C/220 bar.	<input type="checkbox"/>
High-pressure hose, 20 m, ID 10, 220 bar, 2 x EASY!Lock	40	6.110-043.0 with union on both sides, M 22 x 1.5 with anti-kink protection. NW 10/155°C/220 bar	<input type="checkbox"/>
High-pressure hose, 25 m, ID 10, 220 bar, 2 x EASY!Lock	41	6.110-044.0	<input type="checkbox"/>
High-pressure hose, 40 m, ID 10, 220 bar, 2 x EASY!Lock	42	6.110-045.0	<input type="checkbox"/>

■ Included in delivery. □ Available accessories.

EQUIPMENT FOR HD 6/11-4M ST 1.524-939.0



	Order no.	Description	
HIGH-PRESSURE HOSES			
Standard with unions on both sides			
High-pressure hose, 15 m, ID 12, 210 bar, 2 × EASY!Lock	43 6.110-059.0	High-pressure hose for water volumes greater than 1,800 l / h. With union on both sides. 2x M 22 × 1.5 with anti-kink protection.	<input type="checkbox"/>
High-pressure hose, 40 m, ID 12, 210 bar, 2 × EASY!Lock	44 6.110-060.0		<input type="checkbox"/>
Longlife 400 with unions on both sides			
High-pressure hose Longlife, 1,5 m, ID 8, 400 bar, 2 × EASY!Lock	45 6.110-024.0	1,5 m high-pressure hose (DN 8, M 22 × 1,5) with kink protection and connectors at both ends. For connecting to hose reels with appropriate connector (M 22 × 1,5).	<input type="checkbox"/>
High-pressure hose Longlife, 1,5 m, ID 8, 400 bar, 1 × EASY!Lock / 1 × M22 × 1,5	46 6.110-069.0	High-pressure hose (ID 8) with double steel reinforcement, 1,5 m long, suitable for up to 400 bar pressure. Connectors: M 22 × 1,5, quick and convenient EASY!Lock hand screw connection.	<input type="checkbox"/>
High-pressure hose Longlife, 10 m, ID 8, 400 bar, 2 × EASY!Lock	47 6.110-038.0	Durable, 10 m long high-pressure hose (ID 8) with double steel reinforcement and EASY!Lock hand screw connection at both ends and ANTI!Twist. Approved for 400 bar pressure.	<input type="checkbox"/>
High-pressure hose Longlife, 30 m, ID 8, 400 bar, 2 × EASY!Lock	48 6.110-023.0	With rotary coupling, 2 × M 22 × 1,5	<input type="checkbox"/>
High-pressure hose Longlife, 20 m, ID 8, 400 bar, 2 × EASY!Lock	49 6.110-027.0	with rotary coupling, 2 × M 22 × 1,5	<input type="checkbox"/>
High-pressure hose Longlife, 15 m, ID 8, 400 bar, 2 × EASY!Lock	50 6.110-029.0	With rotary coupling, 2 × M 22 × 1,5	<input type="checkbox"/>
Food industry version with unions on both sides			
High-pressure hose food grade, 10 m, ID 8, 250 bar, 2 × EASY!Lock	51 6.110-051.0	10 m high-pressure hose (DN 8) with patented (rotating) AVS trigger gun connector. Non-discolouring outer layer for use in the food industry. M 22 × 1,5 with anti-kink sleeve.	<input type="checkbox"/>
High-pressure hose food grade, 20 m, ID 8, 250 bar, 2 × EASY!Lock	52 6.110-052.0	20 m high-pressure hose (DN 8) with swivel coupling. Non-discolouring outer layer for use in the food industry. Connectors at both ends, M 22 × 1,5, with kink protection. NW 8/155°C/250 bar.	<input type="checkbox"/>
Longlife food industry version with unions on both sides			
High-pressure hose food grade Longlife, 10 m, ID 8, 400 bar, 2 × EASY!Lock	53 6.110-053.0	With blue, non-marking and animal fat resistant outer covering: durable high-pressure hose (ID 8), 10 m long, ANTI!Twist and EASY!Lock hand screw connection at both ends.	<input type="checkbox"/>
High-pressure hose food grade Longlife, 20 m, ID 8, 400 bar, 2 × EASY!Lock	54 6.110-054.0	Longlife HP hose for use in the food industry. Außendecke## animal-grease-resistant, non-colour-bleeding material. With patented AVS connection in the pistol (pivot mounted)	<input type="checkbox"/>
PIPE CLEANING			
Pipe cleaning hose, ID 6			
Hose assembly TR pipe cleaning DN6 14MPa	55 6.110-108.0		<input type="checkbox"/>
	56 6.110-109.0		<input type="checkbox"/>

Available accessories.

EQUIPMENT FOR HD 6/11-4M ST 1.524-939.0



55-57, 61-63



58-60



64



65



66-67



68



69



70

	Order no.	Description	
PIPE CLEANING			
Pipe cleaning hose, ID 6			
Hose assembly TR pipe cleaning DN6 14MPa	57	6.110-110.0	<input type="checkbox"/>
Hose assembly TR pipe cleaning DN6 max.2	58	6.110-046.0	<input type="checkbox"/>
Pipe cleaning hose, DN 6, 20 m, 220 bar	59	6.110-008.0	<input type="checkbox"/>
Hose assembly TR pipe cleaning DN6 max.2	60	6.110-047.0	<input type="checkbox"/>
Hose assembly TR pipe cleaning DN6 14MPa	61	6.110-048.0	<input type="checkbox"/>
Pipe cleaning hose	62	6.110-049.0	<input type="checkbox"/>
Pipe cleaning hose, DN 6, 30 m	63	6.110-050.0	<input type="checkbox"/>
Pipe cleaning nozzle			
Dirt blaster pipe cleaning D21/060	64	4.765-002.0	<input type="checkbox"/>
Dirt blaster pipe cleaning D30/060	65	4.765-005.0	<input type="checkbox"/>
Pipe cleaning nozzle	66	5.763-015.0	<input type="checkbox"/>
	67	5.763-016.0	<input type="checkbox"/>
	68	5.763-017.0	<input type="checkbox"/>
Rotating pipe cleaning nozzle	69	6.415-428.0	<input type="checkbox"/>
FLOOR AND HARD SURFACE CLEANER			
Hard Surface Cleaner FRV 30			
FRV 30	70	2.111-010.0	<input type="checkbox"/>

Available accessories.

EQUIPMENT FOR HD 6/11-4M ST 1.524-939.0



	Order no.	Description		
FLOOR AND HARD SURFACE CLEANER				
Hard Surface Cleaner FRV 30				
Add-on kit rubber lip	71	2.642-910.0	For smooth floors indoors. The squeegee increases the suction performance of the FRV 30 and minimises the amount of water remaining. This means the floor is dry in just a few minutes.	<input type="checkbox"/>
Extension hose 5 m	72	4.440-939.0	5m extension hose for FRV 30. Connection sleeve included.	<input type="checkbox"/>
Add-on kit hose attachment	73	2.642-528.0	Suction cup for fixing the suction hose to smooth surfaces.	<input type="checkbox"/>
Add-on kit dirt trap	74	2.642-532.0	Galvanised steel bucket for collecting coarse dirt and for fixing the suction hose in outside areas.	<input type="checkbox"/>
Hard surface cleaner FR 30				
FR 30 Surface Cleaner	75	2.111-011.0	Up to 10 times greater area coverage compared with the conventional high pressure jet.	<input type="checkbox"/>
Hard surface cleaner FR 30 ME				
FR 30 ME surface cleaner	76	2.111-013.0	Hot water resistant stainless steel surface cleaner with double ceramic bearings, non-marking swivel castors and suction hose connection. Ideal for indoor cleaning, e.g. food industry.	<input type="checkbox"/>
Machine-specific nozzle kit for FR				
Nozzle kit for FR, 500 l/h - 650 l/h	77	2.640-401.0	Nozzle kit includes power nozzles and unions. For Kärcher surface cleaners (500 to 650 l/h).	<input type="checkbox"/>
Hard surface cleaner FRV 30 Me				
FRV 30 Me Surface Cleaner	78	2.111-012.0	Thanks to automatic suction of the dirty water, the stainless steel FRV 30 Me Surface Cleaner makes surface cleaning more efficient in both inside and outside areas. Hot water cleaning up to 85°C.	<input type="checkbox"/>
Extension hose FRV 30 Me and FRV 50 Me	79	4.441-040.0	5 m extension hose for FRV 30 Me. Includes connecting adapter.	<input type="checkbox"/>
FOAM SYSTEMS				
Cup foam lance				
Cup foam lance Advanced 1, 400 l/h - 600 l/h	80	4.112-063.0		<input type="checkbox"/>
Cup foam lance DUO Advanced 1, 400 l/h - 600 l/h	81	4.112-067.0		<input type="checkbox"/>
Cup foam lance Basic 1, 350 l/h - 600 l/h	82	4.112-053.0	For high-pressure cleaners with a flow rate of 350-600 l/h: new, robust and very high-quality foam cup lance with outstanding foam quality while consuming half as much cleaning agent.	<input type="checkbox"/>
1-litre cleaning agent container for cup foam lance basic	83	5.071-414.0		<input type="checkbox"/>
1-litre cleaning agent container for cup foam lance advanced	84	6.414-050.0	Additional 1-litre cleaning agent container for quick replacement of the cleaning agent (for foam lance 2.112-017.0 and 2.112-018.0).	<input type="checkbox"/>

Available accessories.

EQUIPMENT FOR HD 6/11-4M ST 1.524-939.0

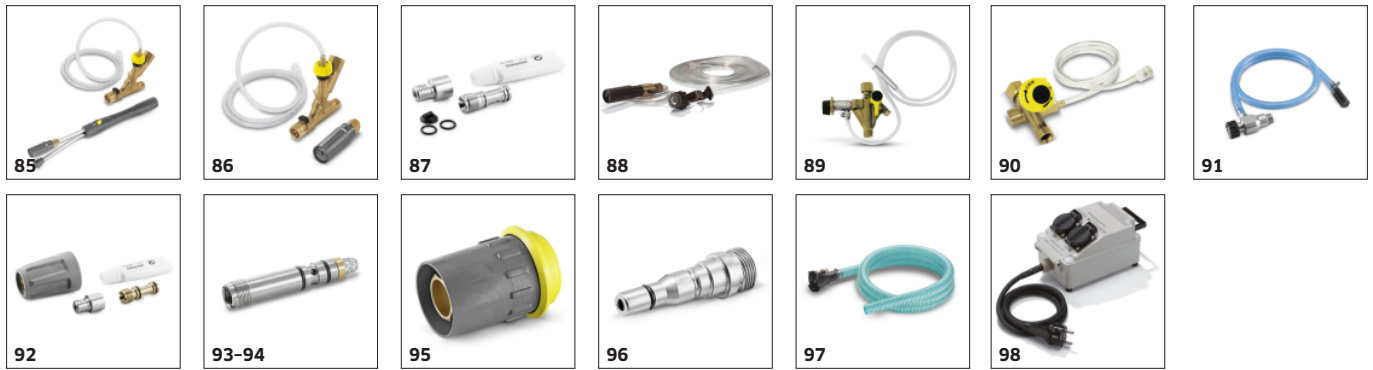

		Order no.	Description	
FOAM SYSTEMS				
Inno Foam Set				
Inno foam kit with detergent injector	85	2.112-000.0	High-pressure foam system with double lance (foam nozzle and high-pressure jet for rinsing). For use with mobile and stationary high-pressure and HDS pressure cleaners for cleaning or disinfection.	<input type="checkbox"/>
Easy Foam Set				
Easy Foam Set with RM injector	86	2.112-010.0	HP foam system for use with HD/HDS units for cleaning and disinfecting. Foam nozzle for connection to lance and HP chemical injector with precision 0-5% metering valve. The machine specific nozzle kit has to be ordered separately.	<input type="checkbox"/>
Nozzle kits for Inno/Easy Foam Set				
Nozzle kit 055 z. Inno/Easy Set 500 - 600 l/h	87	2.111-009.0	Optimal adaptation to different machine outputs for economic use.	<input type="checkbox"/>
Foam nozzle mounting kit				
Foam nozzle kit	88	2.112-013.0	Foaming agent kit. The foam nozzle is ideal for use in sanitary areas and the food industry and wherever long application times are necessary.	<input type="checkbox"/>
MIXERS AND INJECTORS				
HP detergent injector				
Detergent injector for high and low pressure (without nozzles)	89	4.637-032.0	Detergent injector for independent high and low pressure dosage. Maximum dosage about 15%.	<input type="checkbox"/>
Detergent injector for high pressure	90	4.637-033.0	Cleaning agent dosage at high pressure 3 - 5 %	<input type="checkbox"/>
Stainless steel injector kit for HD 6/15C	91	6.645-758.0	Ideal for the HD 6/15 C high-pressure cleaner, the stainless steel injector ensures precise cleaning agent and foam dosage. With suction hose and vacuum filter.	<input type="checkbox"/>
Machine-specific nozzle kit with order no. 3.637-170				
Nozzle insert trapezoidal thread HD-GER.	92	4.769-005.0	For HD 500 - 700 l/h. Consists of nozzle insert + HP power nozzle + union	<input type="checkbox"/>
Nozzle insert with order no. 3.637-001				
Nozzle insert for Order No. 3.637-001, high-pressure for machines up to 1100 l/h.	93	4.769-003.0	Nozzle insert for detergent injector 3.637-001 for high-pressure detergent application. For high-pressure cleaners with a water flow rate up to 1100 l/h.	<input type="checkbox"/>
Low pressure for units rated 1100 l/h or more	94	4.769-006.0	For low pressure with machines above 1.100 l/h	<input type="checkbox"/>
QUICK CONNECT				
Quick-fitting pipe union coupler trapezo	95	2.115-000.0	For fast changes between different spray lances/accessories. Perfect for Kärcher spray unit, suitable for trigger gun/spray lance interface. With M 22 x 1.5 internal thread.	<input type="checkbox"/>
Quick-fitting pipe union plug nipple tra	96	2.115-001.0	Hardened stainless steel male coupling for quick coupling 2.115-000. With M 22 x 1.5 external thread.	<input type="checkbox"/>
DRUM AND TANK CLEANING				
Add-on kit mud sucker	97	2.641-798.0		<input type="checkbox"/>
OTHER HP ACCESSORIES				
Starting current limiter	98	2.637-495.0	Reduces starting current in single-phase supply and protects line fuse.	<input type="checkbox"/>

Available accessories.

EQUIPMENT FOR HD 6/11-4M ST 1.524-939.0



	Order no.	Description	
OTHER HP ACCESSORIES			
Add-on kit coin acceptor	99 2.644-029.0	Coin remote control with electronic coin acceptor for connecting a high-pressure cleaner as a pre-wash device. Please have the power outlet and cable provided on site.	<input type="checkbox"/>
Jet gun	100 2.869-067.0	Short set-up time, easy transport, instant switch off - the jet gun is the affordable cleaning method for all kinds of small to medium-sized areas. Adjustable pressure/water volume.	<input type="checkbox"/>
DICHTUNGEN FÜR TR-GEWINDE			
Spare part set seals TR	101 2.880-001.0		<input type="checkbox"/>
COUPLING PARTS			
Rotary coupling			
Rotary coupling	102 4.111-021.0	Kärcher rotary coupling prevents twisting and kinking of high-pressure hoses for ease of use. Connector Easy!Lock. With grip protection.	<input type="checkbox"/>
Connector			
Nozzle connector/screw connector	103 4.111-022.0	Nozzle connector/screw connector for connecting high-pressure nozzles and accessories to the high-pressure trigger gun (with nozzle connector). Connectors: 1x M 22 x 1.5 and 1x M 18 x 1.5.	<input type="checkbox"/>
Short spray unit	104 4.111-038.0	For attaching high-pressure nozzles and accessory parts to HP trigger gun (with nozzle screws). Not compatible with triple nozzles.	<input type="checkbox"/>
Adapter EASY!Lock			
Adapter 1 M22AG-TR22AG	105 4.111-029.0	Adapter 1 to connect the old hose with the new hose	<input type="checkbox"/>
Adapter 2 M22IG-TR22AG	106 4.111-030.0	Adapter 2 to connect the old device with the new hose and the old gun with the new hose	<input type="checkbox"/>
Adapter 3 M22IG-TR22AG	107 4.111-031.0	Adapter 3 to connect the old gun with the new spray lance and new servo regulator	<input type="checkbox"/>
Adapter M22 - Swivel	108 4.111-032.0	M22 x 1,5female and swivel connection. For extension of high-pressure hoses with AVS connection or for usage of the telescopic lance with a high-pressure hose with AVS connection.	<input type="checkbox"/>
Adapter 5 TR22IG-M22AG	109 4.111-033.0	Adapter 5 to connect the new gun with the old spray lance and new servo regulator with the old spray lance	<input type="checkbox"/>
Adapter 6 TR22IG-M22AG	110 4.111-034.0	Adapter 6 to connect the new device with the old hose and the old hose with the new gun	<input type="checkbox"/>
Adapter 7 M18IG-TR20AG	111 4.111-035.0	Adapter 7 to connect the old spray lance with the new nozzle	<input type="checkbox"/>
Adapter 8 TR20IG-M18AG	112 4.111-036.0	Adapter 8 to connect the new spray lance with the old nozzle	<input type="checkbox"/>

Available accessories.

EQUIPMENT FOR HD 6/11-4M ST 1.524-939.0

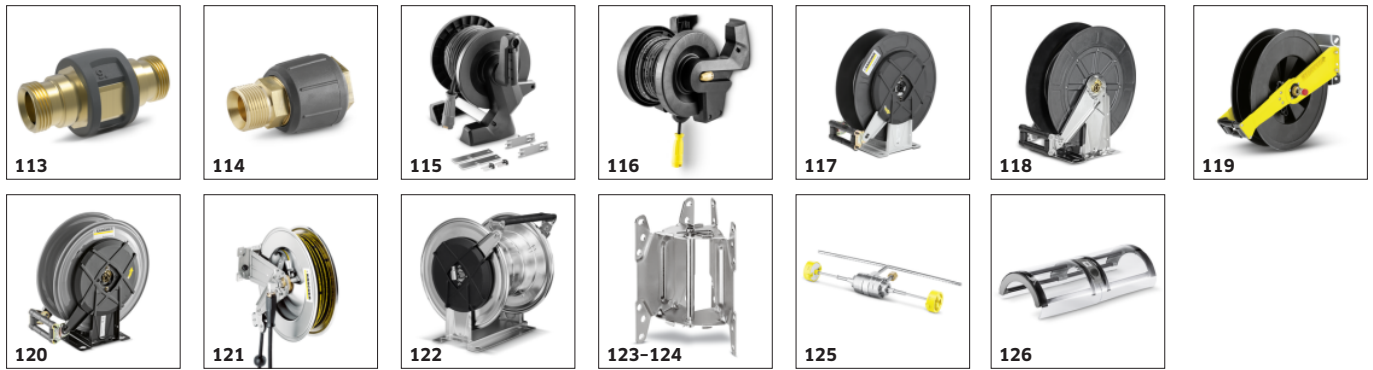

	Order no.	Description	
COUPLING PARTS			
Adapter EASY!Lock			
Coupler -2xM22x1,5	113	4.111-037.0	Brass double connector for connecting and extending high-pressure hoses. With rubber protection. Connector: 2x M 22 × 1.5 m. <input type="checkbox"/>
ADAPTER for replacement TR22IG-M22AG Er	114	4.111-046.0	Rotatable adapter for connecting EASY!Force high-pressure gun and high-pressure hoses with M 22x1.5 connection <input type="checkbox"/>
HOSE REELS			
Hose reel add-on kit			
Hose reel attachment kit for HD middle class, 15 m	115	2.110-024.0	Hose reel attachment kit for high-pressure middle class <input type="checkbox"/>
Automatic, self-winding hose reels			
Automatic plastic hose reel incl. high-pressure hose, 15 m	116	2.639-257.0	<input type="checkbox"/>
Automatic hose reel, powder-coated steel / plastic, 20 m	117	6.392-074.0	Automatic hose reel for 20 m high-pressure hose. The console is made from powder-coated steel, the drum is made from plastic. <input type="checkbox"/>
Automatic stainless steel / synthetic material hose drum, 20 m	118	6.392-083.0	Automatic hose reel for 20 m high-pressure hose. The console consists of stainless steel, the drum is made from plastic. <input type="checkbox"/>
Automatic hose reel, coated, 20 m	119	6.392-106.0	Automatic hose reel of durable plastic. Painted steel bracket. Suitable for 20 m high-pressure hose. <input type="checkbox"/>
Hose reel, automatic, basalt grey-coated, 20 m	120	6.392-105.0	Automatic hose reels provide the highest level of safety and convenience for winding and unwinding HP hoses. <input type="checkbox"/>
Automatic hose reel, stainless steel, includes swivel holder, 20 m	121	6.392-076.0	Automatic stainless steel hose reel. With swivel holder. Suitable for 20 m high-pressure hose. <input type="checkbox"/>
Automatic stainless steel hose reel, 40 m	122	6.392-442.0	Automatic hose reels provide the highest level of safety and convenience for winding and unwinding HP hoses. Compatible high-pressure hose, e.g. order no. 6.110-076.0 (ID 8, 40 m, 400 bar, 1x hose reel connection attachment kit). <input type="checkbox"/>
Powder-coated swivel holder	123	2.639-931.0	Swivel holder for automatic hose reel wall mounting. For maximum action radius and flexibility of high-pressure hose. Rotatable 120°. Galvanised steel. <input type="checkbox"/>
Stainless steel swivel holder	124	2.641-867.0	Swivelling wall bracket made of high-grade steel (for 2.641-866). This makes maximum flexibility and convenience possible when working with the HP hose. <input type="checkbox"/>
FACADE AND SOLAR PANEL CLEANING			
Brushes			
Drive for roller brush 500	125	4.762-584.0	Hydraulic drive for rotating roller brushes. For cleaning façades or solar power installations with our professional high-pressure cleaners. Installation on spray lance or telescopic lance. <input type="checkbox"/>
Splash guard for roller brush 500	126	4.762-621.0	Splash guard with velcro fastening for rotating roller brush. Clear view of the brush thanks to transparent film, with protection against splashes at the same time. <input type="checkbox"/>

Available accessories.

EQUIPMENT FOR HD 6/11-4M ST 1.524-939.0



		Order no.	Description	
FACADE AND SOLAR PANEL CLEANING				
Brushes				
Roller brush 500 soft	127	4.762-623.0	Soft brush attachment for use with hydraulic drive (4.762-584.0). Ideal for glass and solar power installation cleaning. Easy quick-change system and secure mounting on drive.	<input type="checkbox"/>
Roller brush 500 medium	128	4.762-624.0	Medium-hard brush attachment for use with hydraulic drive (4.762-584.0). Suitable for sensitive façades, foils and fabrics. Easy and safe quick-change system.	<input type="checkbox"/>
Roller brush 500 hard	129	4.762-625.0	Hard brush attachment for use with hydraulic drive (4.762-584.0). For rough façades, stone and wooden patios. Safe and easy quick-change system.	<input type="checkbox"/>
Brush hard	130	6.960-133.0	Brush with hard bristles for cleaning industry façades and floor coverings and removing coarse dirt. Simple installation on telescopic lances or high-pressure lances from Kärcher.	<input type="checkbox"/>
Brush medium	131	6.960-134.0	Optimally cleans façades, roller shutters and textile fabrics: the brush with medium-hard bristles for fast and simple attachment to telescopic lances or high-pressure lances from Kärcher.	<input type="checkbox"/>
Brush soft	132	6.960-135.0	For simple installation on telescopic lances or high-pressure lances from Kärcher: brush with soft bristles for deep cleaning of sensitive surfaces such as glass or solar systems.	<input type="checkbox"/>
iSolar 400 Advanced	133	6.368-092.0	iSolar 400 brush for water flow rate of 700-1,000 l/h. The water-driven disc brush with a width of 400 mm cleans small to medium-sized photovoltaic systems. Also perfect for use on elevated systems.	<input type="checkbox"/>
Telescopic				
TL low pressure adapter	134	4.580-097.0	TL low-pressure adapter comprising ball valve for tool-free installation on telescopic lances. Ideal for applications with rotating high-pressure brushes.	<input type="checkbox"/>
Telescopic lance TL 7 F	135	4.762-609.0	Telescopic lance TL 7 F with up to 7 m reach made from robust and lightweight glass fibre. With practical quick-release fasteners for simple retraction and extension.	<input type="checkbox"/>
Telescopic lance TL 7 H	136	4.762-610.0	Multifunctional hybrid telescopic lance TL 7 H made of rigid and lightweight carbon-glass fibre mix. Telescopic thanks to quick-release fastenings. Up to 7 m reach.	<input type="checkbox"/>
Telescopic lance TL 10 H	137	4.762-611.0	Up to 10 m reach: hybrid telescopic lance TL 10 H. Comprising carbon-glass fibre mix and suitable for multifunctional use. Simple retraction and extension thanks to quick-release fasteners.	<input type="checkbox"/>
Telescopic lance TL 10 C	138	4.762-612.0	Carbon fibre telescopic lance TL 10 C. With up to 10 m reach and practical quick-release fasteners. Multifunctional use for cleaning façades, windows or solar panels.	<input type="checkbox"/>
Telescopic lance TL 14 C	139	4.762-613.0	Maximum rigidity with minimum weight: telescopic lance TL 14 C made from carbon fibre. Enormous reach of 14 m, multifunctional use and easy to use thanks to quick-release fasteners.	<input type="checkbox"/>
TL high pressure adapter	140	4.775-154.0	TL high-pressure adapter, flexible high-pressure gun for high-pressure cleaning with telescopic lances. Ergonomic, easy to install, suitable for right- and left-handed individuals.	<input type="checkbox"/>

Available accessories.

EQUIPMENT FOR HD 6/11-4M ST 1.524-939.0



141-142



143



144-146



147



148-149



150



151



152

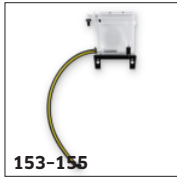

153-155

	Order no.	Description		
FACADE AND SOLAR PANEL CLEANING				
Wasserenthärtung				
WS 50	141	6.368-463.0	The mobile WS 50 water softening unit prevents lime residue on clean surfaces. A special ion-exchange resin removes the dissolved limescale from the water.	<input type="checkbox"/>
WS 100	142	6.368-464.0	The mobile WS 100 water softening unit prevents lime residue on clean surfaces. A special ion-exchange resin removes the dissolved limescale from the water.	<input type="checkbox"/>
WS Regenerator	143	6.368-465.0	With the WS Regenerator regeneration system, the softening cartridges of the water softening units WS 50 and WS 100 can be backflushed and regenerated at the push of a button.	<input type="checkbox"/>
Hoses				
Hose solar	144	6.392-978.0	High-quality, flexible HP hose (with rubber covering) for the iSolar TL 7. The outer layer has especially good sliding properties when extending and retracting the telescopic rod.	<input type="checkbox"/>
	145	6.392-977.0	High-quality, flexible HP hose (with rubber covering) for the iSolar TL 10. The outer layer has especially good sliding properties when extending and retracting the telescopic rod.	<input type="checkbox"/>
	146	6.392-976.0	High-quality, flexible HP hose (with rubber covering) for the iSolar TL 14. The outer layer has especially good sliding properties when extending and retracting the telescopic rod.	<input type="checkbox"/>
Attachment kits and adapters				
Case sheet steel	147	6.988-152.0	Certified personal security system for rooftop work. Contents: Travelling fall arrestor with shock absorber and 15 m kernmantle rope, harness, anchoring sling and sheet steel case.	<input type="checkbox"/>
WET BLASTING ATTACHMENT				
Wet blasting attachment (without nozzle)				
Wet blasting attachment with flow control (without nozzles)	148	4.115-000.0	Paint, rust and scale removal made easy: Kärcher wet blasting attachment with flow control for adding blasting abrasive to the high-pressure jet.	<input type="checkbox"/>
Wet blasting attachment without flow control (nozzles not included)	149	4.115-006.0	Paint, rust and scale removal made easy: Kärcher wet blasting attachment with flow control for adding blasting abrasive to the high-pressure jet. Without flow control.	<input type="checkbox"/>
Nozzle pack for wet blasting attachment				
Nozzle pack TR wet jet set 0045	150	2.112-022.0	Nozzle kit with wet blasting nozzle and nozzle insert (type specific). For optimal Kärcher wet blasting attachment performance. Only in combination with wet blasting attachment 4.115-000.0 4.115-006.0.	<input type="checkbox"/>
Boron carbide nozzle				
Boron carbide nozzle, for machines as of 1000 l/h	151	6.415-084.0	In addition to nozzle packs. Very wear-resistant nozzle with boron carbide chuck for continuous-duty operation.	<input type="checkbox"/>
ADD-ON KITS				
HP stationary attachment kit				
Add-on kit float	152	2.637-736.0		<input type="checkbox"/>
WATER CONNECTION				
Geka coupling				
With hose nozzle, R 1/2"	153	6.388-461.0	with hose liner	<input type="checkbox"/>
With hose nozzle, R 3/4"	154	6.388-455.0		<input type="checkbox"/>

Available accessories.

EQUIPMENT FOR HD 6/11-4M ST 1.524-939.0



		Order no.	Description	
WATER CONNECTION				
Geka coupling				
With hose nozzle, R 1"	155	6.388-465.0	with hose barb	<input type="checkbox"/>
With female thread, R 3/4"	156	6.388-473.0	with female thread	<input type="checkbox"/>
Suction filter				
Water filter	157	6.414-956.0	Suitable for ponds, storage tanks or similar, polyamide filter casing, stainless steel strainer, 800 µm mesh, R 3/4" and R 1" connection, without non-return valve	<input type="checkbox"/>
Suction filter with check valve	158	4.730-012.0	Brass suction filter suitable for ponds, storage tanks, etc. With check valve.	<input type="checkbox"/>
Fine-mesh water filter				
Add-on kit water filter universal	159	2.637-020.0		<input type="checkbox"/>
Fine-mesh water filter, 100 µm, R 3/4"	160	2.637-691.0	Fine-mesh water filter, 100 µm, max. temperature 60°C. Protects the high-pressure cleaner from dirt particles contained in the water. Transparent filter cup. Water flow rate up to 1200 l/h. Connector 3/4".	<input type="checkbox"/>
Fine-mesh water filter with adapter	161	4.730-102.0	Fine-mesh water filter, 125 µm, max. temperature 50°C. Protects the high-pressure cleaner from dirt particles contained in the water. Water flow rate up to 1200 l/h. Connection 3/4", with adapter, 1".	<input type="checkbox"/>
WASHING BRUSHES				
Push-on washing brush				
Push-on wash brush, M 18 × 1.5	162	4.113-001.0	Push-on wash brush for universal use. Simply push on to lance. Connector: M 18 × 1.6.	<input type="checkbox"/>
Rotating washing brush				
Rotating wash brush for < 800 l/h machines, nylon bristles	163	4.113-004.0	The rotating wash brush gently removes fine dust and traffic film from all surfaces. Temperature resistant up to 60°C. (M 18 × 1.5, replaceable brush insert).	<input type="checkbox"/>
Rotating wash brush for < 800 l/h machines, natural bristles	164	4.113-003.0	Driven by water stream. Gently removes fine dust and traffic film from any surface. Temperature resistant up to 60°C, M 18 × 1.5 (replaceable brush insert).	<input type="checkbox"/>
DRUM AND TANK CLEANING				
Barrel and tank cleaning				
Rotary cleaner head M63E	165	6.751-061.0		<input type="checkbox"/>

Available accessories.